



Standard Material Certification for Conformance and Delivery - Excel SD-3™

"Blanketing Nature With Nature"

To Whom it May Concern:

This document has been drafted to certify Western Excelsior manufactures the Rolled Erosion Control Product (RECP) marketed as Excel SD-3. Each blanket is subjected to Western Excelsior's Quality Assurance Program and is manufactured to the specifications listed in document number WE_EXCEL_SD3_SPEC. Further, Western Excelsior utilizes industry standardized test procedures to develop performance references for Excel SD-3. Document number WE_EXCEL_SD3_PERF presents the industry standardized testing and results. Installation instructions are provided in document numbers WE_EXCEL_SD3_SII and WE_EXCEL_SD3_CII for hillslope and channel installations, respectively. A copy of document number WE_EXCEL_SD3_SPEC is attached; all other documentation may be obtained by calling Western Excelsior Technical Services at 1-866-540-9810, at www.westernexcelsior.com or by email at wexcotech@westernexcelsior.com.

Since most Western Excelsior products are sold to distributors and stocked, Western Excelsior is typically unable to certify material type or quantity delivered to the project/project site. However, space is provided below for distributor/contractor certification of materials delivered to the project/project site.

Regards,

A handwritten signature in black ink, appearing to read "Chad M. Lipscomb".

Chad M. Lipscomb, PE (CO), CPESC
Director, Technical Services
Western Excelsior Corporation
chad@westernexcelsior.com
866-540-9810

Standard Material Delivery Certification

Material Provided by (Distributor/Contractor): _____

Material Provided to (Contractor/Project): _____

Project Name / Project Number: _____

Rolls/Square Yards Provided: _____

Specification #: _____

Signature: _____

Date: _____

Title: _____



"Blanketing Nature With Nature"

Chad Lipscomb, PE (CO), CPESC
Director, Technical Services
Western Excelsior Corporation
4609 E. Boonville-New Harmony Rd.
Evansville, IN 47725
(970) 682-4594 Direct (Voice/Text)
chad@westernexcelsior.com

Effective: 6/27/2017

RE: Certificate of Conformance: Excel SD-3™

To Whom it May Concern:

This letter is to certify that Western Excelsior manufactures the Rolled Erosion Control Product (RECP) marketed as EXCEL SD-3. Each blanket is subjected to Western Excelsior's Quality Assurance Program and is manufactured to the specifications listed in document number WE_EXCEL_SD3_SPEC. Further, Western Excelsior utilizes industry standardized test procedures to develop performance references for Excel SD-3. Document number WE_EXCEL_SD3_PERF presents the industry standardized testing and results. Installation instructions are provided in document numbers WE_EXCEL_SD3_SII and WE_EXCEL_SD3_CII for hillslope and channel installations, respectively. A copy of document number WE_EXCEL_SD3_SPEC is attached; all other documentation may be obtained by calling Western Excelsior Technical Services at 1-866-540-9810, at www.westernexcelsior.com or by email at wexcotech@westernexcelsior.com.

Regards,

A handwritten signature in black ink, appearing to read "Chad M. Lipscomb".

Chad M. Lipscomb, PE (CO), CPESC
Director, Technical Services
Western Excelsior Corporation

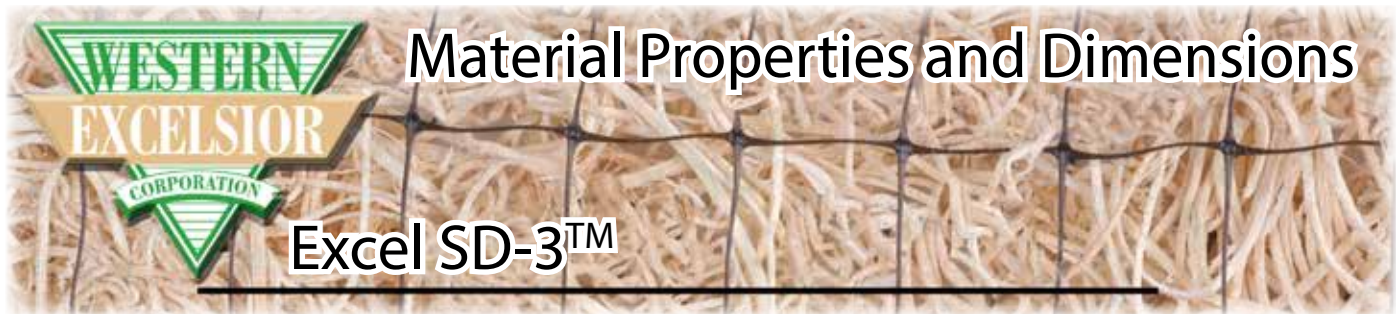

Material Properties and Dimensions

Excel SD-3™



Specifications

Western Excelsior manufactures a full line of Rolled Erosion Control Products (RECPs). Excel SD-3 extended term Erosion Control Blanket is composed of a 100% High Altitude Rocky Mountain Aspen Excelsior matrix mechanically (stitch) bound on two inch centers between two long term photodegradable, synthetic heavy duty nets. The excelsior matrix consists of curled, machine produced fibers with greater than eighty percent longer than six inches. Excel SD-3 blanket is intended for use in channels or slopes requiring erosion protection for a period up to thirty months. Actual field longevity is dependent on soil and climatic conditions.

Each roll of EXCEL SD-3 is made in the USA and manufactured under Western Excelsior's Quality Assurance Program to ensure a continuous distribution of fibers and consistent thickness. Typical manufactured properties are provided in Table 1 and product characteristics are provided in Table 2.

Table 1- Specified Expected Values

| Tested Property | Test Method | Value |
|------------------------------|-------------|---|
| Tensile Strength (MD) x (TD) | ASTM D6818 | 18.4 lb/in (3.2 kN/m) x 12.7 lb/in (2.2 kN/m) |
| Elongation (MD) x (TD) | ASTM D6818 | 25 % x 25 % |
| Mass Per Unit Area | ASTM D6475 | 18.0 oz/yd ² (610 g/m ²) |
| Thickness | ASTM D6525 | 0.55 in (14 mm) |
| Light Penetration | ASTM D6567 | 15 % open |
| Water Absorption | ASTM D1117 | 300 % |

Table 2 - Netting

| | |
|-------------------------------|---------------------------------|
| Top Net Type | Synthetic, UV Stable |
| Bottom Net Type | Synthetic, UV Stable |
| Top Net Opening Dimensions | 0.7 in (17 mm) x 0.7 in (17 mm) |
| Bottom Net Opening Dimensions | 0.7 in (17 mm) x 0.7 in (17 mm) |

Excel SD-3 is available in multiple roll sizes ranging in width from 4.0 ft to 16.0 ft. and 50.0 ft to 450 ft in length. Standard roll sizes are 44.4 square yards, measuring 4.0 ft wide by 100.0 ft long. Custom roll sizes are available upon request.

The information contained herein may represent product index data, performance ratings, bench scale testing or other material utility quantifications. Each representation may have unique utility and limitations. Every effort has been made to ensure accuracy, however, no warranty is claimed and no liability shall be assumed by Western Excelsior Corporation (WEC) or its affiliates regarding the completeness, accuracy or fitness of these values for any particular application or interpretation. While testing methods are provided for reference, values shown may be derived from interpolation or adjustment to be representative of intended use. For further information, please feel free to contact WEC.



Design Data and Test Results

Excel SD-3™



Specifications

A variety of test methods are utilized to determine performance and conformance values for Rolled Erosion Control Products (RECPs). Information within this document is presented to provide conformance values and recommended design values. Test results obtained for the Excel SD-3 Extended Term Erosion Control Blanket (ECB) and general design values are presented in Tables 1-4. For specific information detailing testing protocols, results and application of design values, refer to document number WE_EXCEL_PERF_GEN.

Table 1 - Bench Scale Testing / NTPEP

| Test Method | Condition | Result |
|--|-------------------------------------|----------------|
| ASTM D7101 Bench Scale Rainfall and Rainsplash Test | 2 in per hour | 16.39 |
| | 4 in per hour | 18.26 |
| | 6 in per hour | 20.34 |
| ASTM D7207 Bench Scale Shear Resistance Test | 3.4 psf (164 PA) | 0.5 in (12 mm) |
| ASTM D7322 Bench Scale Vegetation Establishment Test | Top Soil, Fescue, 21 Day Incubation | 320 % |
| NTPEP Report Number | ECP-2012-03-002 | |

Table 3 - Recommended Design Values*

| Design Value | Unvegetated | Vegetated |
|---|--------------------|---------------------|
| Typical RUSLE Cover Factor (C Factor)** | 0.05 | N/A |
| Maximum Slope Gradient (RUSLE) | 1.5H : 1V | N/A |
| Max Allowable Velocity (0.5 in (12mm) soil loss)*** | 8.0 ft/s (2.4 m/s) | 12.0 ft/s (3.7 m/s) |
| Max Allowable Shear Stress (0.5 in (12mm) soil loss)*** | 2.8 psf (134 PA) | 8.0 psf (383 PA) |
| CF _{veg} /CF _{TRM} | N/A | N/A |

C Factor value compliant with ASTM D6459. * Shear Stress and Velocity values compliant with ASTM D6460.

Table 2 - Texas Transportation Institute (TTI) Results

| Class | Test Condition | Result |
|-------|--|----------|
| A | < 3H:1 Clay Slope Test | N/A |
| B | < 3H:1 Sand Slope Test | N/A |
| C | > 3H:1 Clay Slope Test | N/A |
| D | > 3H:1 Sand Slope Test | N/A |
| E | 2 psf Partially Vegetated Channel Test | Approved |
| F | 4 psf Partially Vegetated Channel Test | Approved |
| G | 6 psf Partially Vegetated Channel Test | N/A |
| H | 8 psf Partially Vegetated Channel Test | N/A |

Table 4 - HEC-15 Resistance to Flow Values

| Design Value | Unvegetated |
|--|-------------|
| Manning's n @ Tau lower (0.7 psf (34 PA)) | 0.040 |
| Manning's n @ Tau mid (1.4 psf (67 PA)) | 0.030 |
| Manning's n @ Tau upper (2.8 psf (134 PA)) | 0.029 |

*Recommended Design Values are based on results of standardized industry full-scale testing and may not be applicable for all field conditions. For most accurate computation of field performance, consult Excel Erosion Design (EED) at www.westernexcelsior.com.

The information contained herein may represent product index data, performance ratings, bench scale testing or other material utility quantifications. Each representation may have unique utility and limitations. Every effort has been made to ensure accuracy, however, no warranty is claimed and no liability shall be assumed by Western Excelsior Corporation (WEC) or its affiliates regarding the completeness, accuracy or fitness of these values for any particular application or interpretation. While testing methods are provided for reference, values shown may be derived from interpolation or adjustment to be representative of intended use. For further information, please feel free to contact WEC.



Slope Installation Instructions EXCEL SD-3™

* Drawings Not to Scale

Step 1 - Site Preparation

Prepare site to design profile and grade. Remove debris, rocks, clods, etc.. Ground surface should be smooth prior to installation to ensure blanket remains in contact with slope.

Step 2 - Seeding

Seeding of site should be conducted to design requirements or to follow local or state seeding requirements as necessary.

Step 3 - Staple Selection

At a minimum, 6 in. long by 1 in. crown, 11 gauge staples are to be used to secure the blanket to the ground surface. Installation in rocky, sandy or other loose soil may require longer staples.

Step 4 - Excavate Anchor Trench and Secure Blanket

Excavate a trench along the top of the slope to secure the upstream end of the blanket. The trench should run along the length of the installation, be 6 in. wide and 6 in. deep. Staple blanket along bottom of trench, fill with compacted soil, overlap blanket towards toe of slope and secure with row of staples (shown in Figures A, E and F).

Step 5 - Secure Body of Blanket

Roll blanket down slope from anchor trench. Staple body of blanket following the pattern shown in Figure D. Leave end of blanket unstapled to allow for overlap shown in Figure B. Place downstream blanket underneath upstream blanket to form shingle pattern. Staple seam as shown in Figure E. Secure downstream blanket with stapling pattern shown in Figure D. Stapling pattern shown in Figure D reflects minimum staples to be used. More staples may be required to ensure blanket is sufficiently secured to resist mowers and foot traffic and to ensure blanket is in contact with soil surface over the entire area of blanket. Further, critical points require additional staples. Critical points are identified in Figure G.

Step 6 - Continue Along Slope - Complete Installation

Overlap adjacent blankets as shown in Figure C and repeat Step 5. Secure toe of slope using stapling pattern shown in Figure E. Secure edges of installation by stapling at 1.0' intervals along the terminal edge.

Figure A

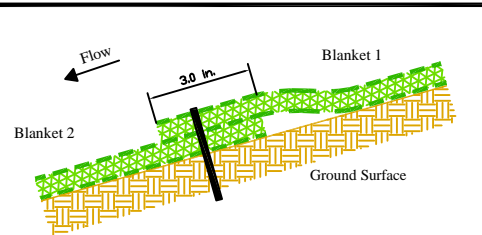

Figure B - Profile View

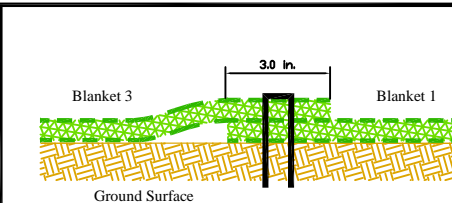

Figure C - Cross Section View

Product Application/Equivalency Specifications

Excel SD-3 is produced by Western Excelsior and consists of a long term Rolled Erosion Control Product (RECP) comprised of an excelsior matrix mechanically (stitch) bound between two, UV stabilized, heavy duty synthetic nets (top and bottom). The expected longevity of Excel SD-3 is approximately 30 months (actual longevity dependent on field and climatic conditions). Excel SD-3 is manufactured to include physical properties sufficient to provide the intended longevity and performance. Product specifications may be found on document WE_EXCEL_SD3_SPEC and performance information may be found on document WE_EXCEL_SD3_PERF. All documents are available from Western Excelsior Technical Support or www.westernexcelsior.com. Additional to above, equivalent products to Excel SD-3 must meet identical criteria as Excel SD-3 as follows:

1. Consist of machine produced, weed and debris free excelsior bound between two, UV stabilized, heavy duty synthetic nets.
2. Sufficient tensile strength, thickness and coverage to maintain integrity during installation and ensure material performance.
3. Listing within AASHTO NTPEP database.
4. Meet ECTC specification for category 4 product.

Figure E

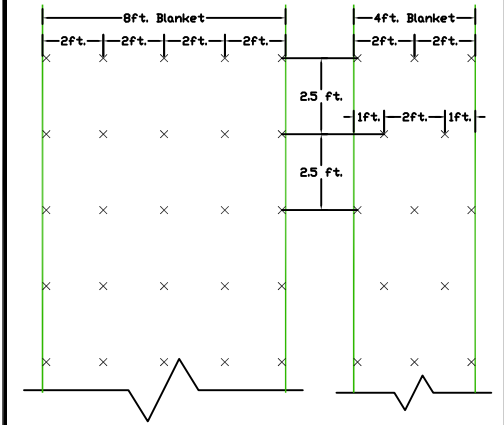
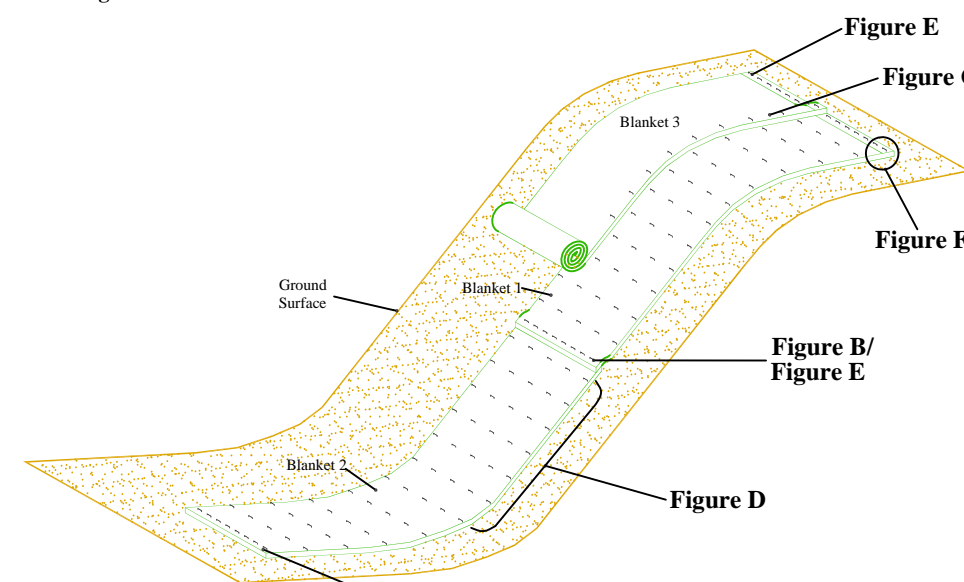

× - Denotes Staple Location

Figure D - Plan View

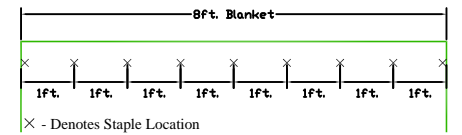

× - Denotes Staple Location

Figure E - Plan View

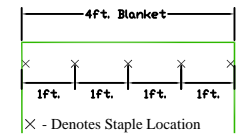

× - Denotes Staple Location

Figure E - Plan View

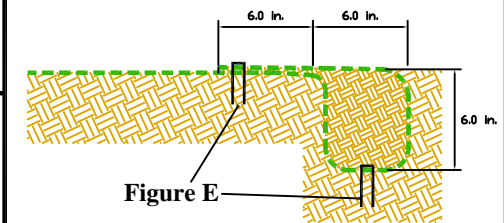

Figure E

Figure F - Profile View

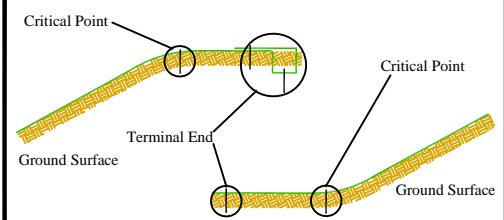

Figure G - Critical Point Securing



Channel Installation Instructions EXCEL SD-3™

* Drawings Not to Scale

Step 1 - Site Preparation

Prepare site to design profile and grade. Remove debris, rocks, clods, etc.. Ground surface should be smooth prior to installation to ensure blanket remains in contact with slope.

Step 2 - Seeding

Seeding of site should be conducted to design requirements or to follow local or state seeding requirements as necessary.

Step 3 - Staple Selection

At a minimum, 6 in. long by 1 in. crown, 11 gauge staples are to be used to secure the blanket to the ground surface. Installation in rocky, sandy or other loose soil may require longer staples.

Step 4 - Excavate Anchor Trench and Secure Blanket

Excavate a trench along the top of the channel side slopes and the upstream terminal end of the channel to secure the edges of the blanket. The trench should run along the length and width of the installation, be 6 in. wide and 6 in. deep. Staple blanket along bottom of trench, fill with compacted soil, overlap blanket towards toe of slope and secure with row of staples (shown in Figures A, E and F).

Step 5 - Secure Body of Blanket

Roll blanket down slope from anchor trench. Staple body of blanket following the pattern shown in Figure D. Leave end of blanket unstapled to allow for overlap shown in Figure B. Place downstream blanket underneath upstream blanket to form shingle pattern. Staple seam as shown in Figure E. Secure downstream blanket with stapling pattern shown in Figure D. Stapling pattern shown in Figure D reflects minimum staples to be used. More staples may be required to ensure blanket is sufficiently secured to resist mowers and foot traffic and to ensure blanket is in contact with soil surface over the entire area of blanket. Further, critical points require additional staples. Critical points are identified in Figure G.

Step 6 - Continue Along Slope - Complete Installation

Overlap adjacent blankets as shown in Figure C and repeat Step 5. Secure toe of slope using stapling pattern shown in Figure E. Secure edges of installation by stapling at 1.0' intervals along the terminal edge.

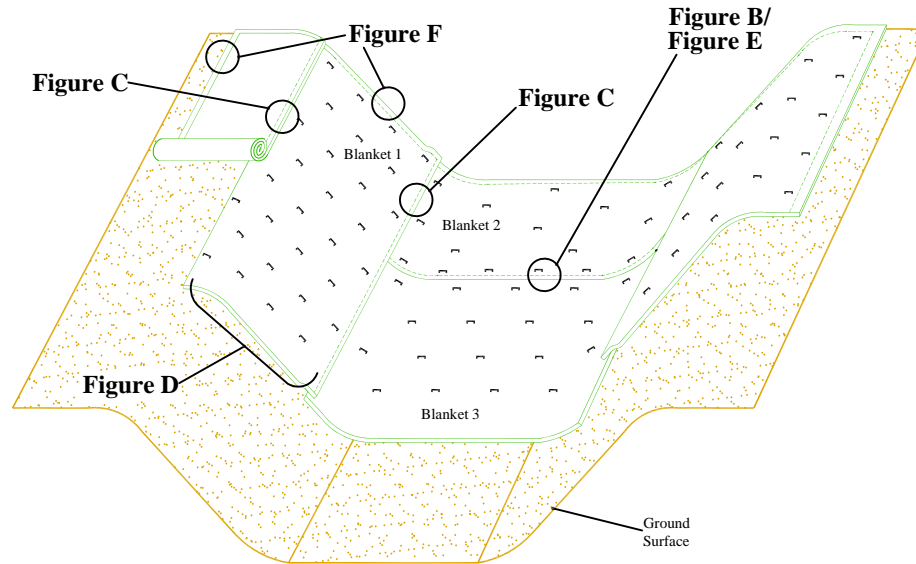

Figure A

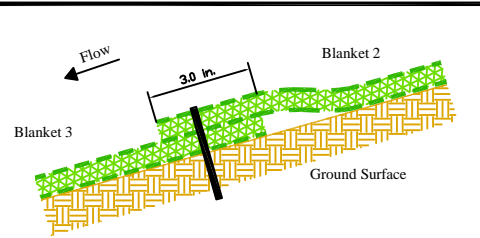

Figure B - Profile View

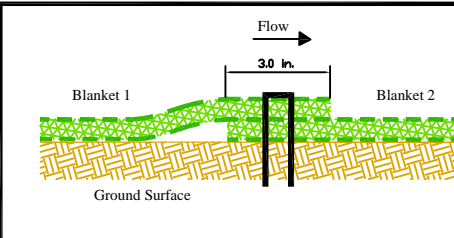
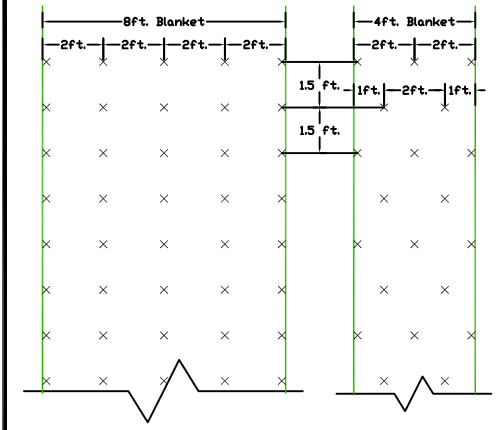

Figure C - Cross Section View

Product Application/Equivalency Specifications

Excel SD-3 is produced by Western Excelsior and consists of a long term Rolled Erosion Control Product (RECP) comprised of an excelsior matrix mechanically (stitch) bound between two, UV stabilized, heavy duty synthetic nets (top and bottom). The expected longevity of Excel SD-3 is approximately 30 months (actual longevity dependent on field and climatic conditions). Excel SD-3 is manufactured to include physical properties sufficient to provide the intended longevity and performance. Product specifications may be found on document WE_EXCEL_SD3_SPEC and performance information may be found on document WE_EXCEL_SD3_PERF. All documents are available from Western Excelsior Technical Support or www.westernexcelsior.com. Additional to above, equivalent products to Excel SD-3 must meet identical criteria as Excel SD-3 as follows:

1. Consist of machine produced, weed and debris free excelsior bound between two, UV stabilized, heavy duty synthetic nets (top and bottom).
2. Sufficient tensile strength, thickness and coverage to maintain integrity during installation and ensure material performance.
3. Listing within AASHTO NTPEP database.
4. Meet ECTC specification for category 4 product.



× - Denotes Staple Location

Figure D - Plan View

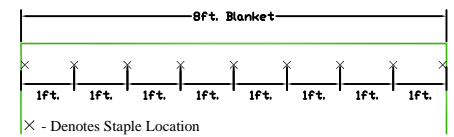

× - Denotes Staple Location

Figure E - Plan View

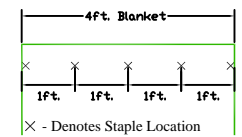

× - Denotes Staple Location

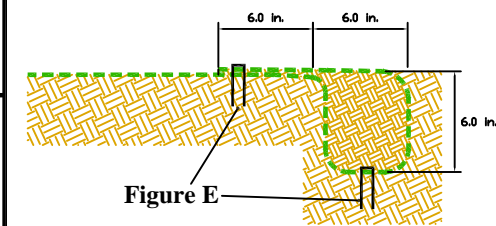

Figure E

Figure F - Profile View

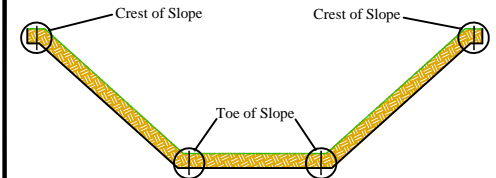

Figure G - Critical Point Securing

Paso 1 - Preparación del Lugar

Prepare el lugar según el perfil del diseño y de la pendiente. Remueva el escombros, piedras, y terrones, etc. La superficie de la tierra debe estar lisa antes de la instalación para asegurar que el cojín permanezca en contacto con la pendiente.

Paso 2 - Semilla

El sembrado de la semilla en el lugar se debe hacer de acuerdo a los requisitos del diseño o a los requisitos locales y estatales, según sea necesario.

Paso 3 - Selección de Grapas

Lo mínimo que se debe usar son grapas de calibre 11, de 6 in. de largo y 1 in. de corona para sujetar el cojín a la superficie de la tierra. La instalación en tierra rocosa, arenosa o suelta puede requerir grapas más largas.

Paso 4 - Excave Zanja para Anclaje y Sujete el Cojín

Excave una zanja a lo largo de la parte superior de las pendiente para sujetar la punta de arriba del cojín. La zanja debe correr a lo largo de la instalación, tener 6 in. de ancho y 6 in. de profundidad. Engrape el cojín a lo largo del fondo de la zanja; llénela con tierra compactada, empalme el cojín hacia la parte inferior de la pendiente y sujételo con una hilera de grapas (Vea las Figuras A, E y F).

Paso 5 - Sujete el Cuerpo del Cojín

Desenrolle el cojín hacia abajo desde la zanja de anclaje. Engrape el cuerpo del cojín siguiendo el patrón que se muestra en la Figura D. Deje la punta del cojín sin engrapar para que lo pueda empalmar como se muestra en la Figura B. Coloque el cojín que baja por debajo del de arriba para formar un patrón como de tejas. Engrape las uniones como se muestra en la figura E. Sujete el cojín de bajada con el patrón de engrapado que se muestra en la Figura D. El patrón de engrapado de la Figura D refleja el mínimo de grapas que se debe usar. Se pueden requerir más grapas para asegurar que el cojín quede sujetado suficientemente para resistir podadoras y tráfico a pie y para asegurar que el cojín permanezca en contacto con la superficie de la tierra en toda el área. Además, los puntos críticos requieren grapas adicionales. Los puntos críticos están identificados en la Figura G.

Paso 6 - Continúe a lo largo de la Pendiente - Termine la Instalación

Empalme los cojines adyacentes como se muestra en la Figura C y repita el Paso 5. Sujete la parte inferior de la pendiente usando el patrón de grapas que se muestra en la Figura E. Sujete las orillas de la instalación engrapando a intervalos de 1.0' a lo largo de la orilla.

* El Dibujo No Está a Escala Se.



Figura A



Figura B - Vista de Perfil

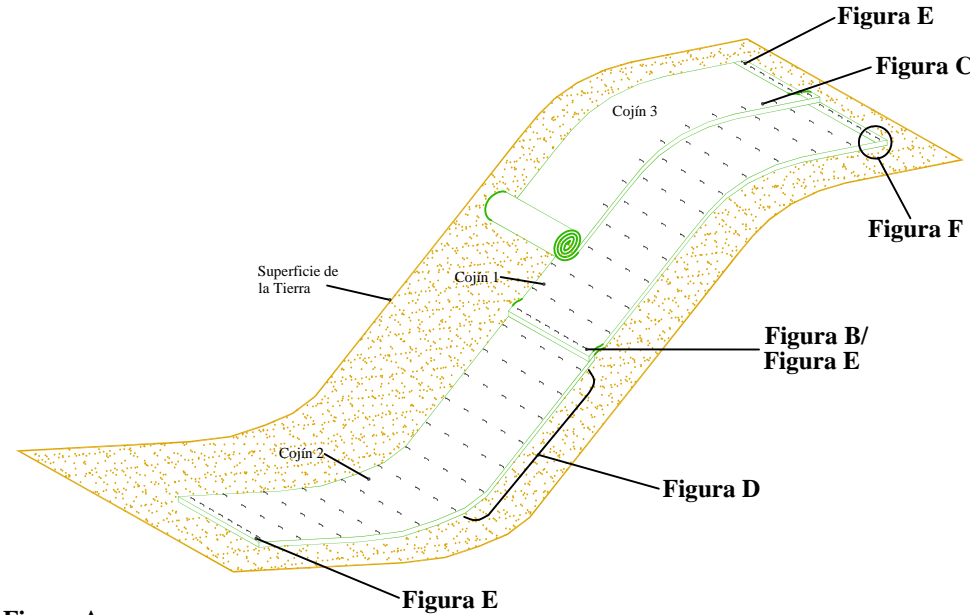

Figura C - Corte de Vista Transversal

Aplicación del Producto/Especificaciones de Equivalencia

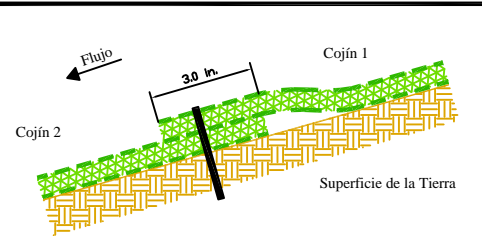
Excel SD-3 es producido por Western Excelsior y consiste de un Producto en Rollo para Control de la Erosión por un término largo (PCER), formado de una matriz de excelsior unida mecánicamente (cosida) entre dos redes sintéticas, de uso rudo, estabilizadas UV (parte superior e inferior). La vida útil del EXCEL SD-3 es aproximadamente 30 meses. (La vida útil real depende del campo y de las condiciones climáticas). El Excel SD-3 se fabrica para incluir propiedades físicas suficientes para proporcionar la vida útil y rendimiento esperado. Las especificaciones del producto se encuentran en el documento WE_EXCEL_SD3_SPEC y la información de rendimiento se puede encontrar en el documento WE_EXCEL_SD3_PERF. Todos los documentos están disponibles en Western Excelsior Technical Support (Soporte Técnico de Western Excelsior) o en www.westernexcelsior.com. Además de lo anterior, los productos equivalentes a Excel SD-3 deben cumplir con los siguientes criterios idénticos a Excel SD-3:

1. Consistente en excelsior producido a máquina, libre de hierbas y basura unido entre dos redes sintéticas de uso rudo, estabilizadas UV (superior e inferior).
2. Suficiente fuerza de tensión, grosor y cobertura para mantener su integridad durante la instalación y asegurar el rendimiento del material.
3. Incluido en la base de datos AASHTO NTPEP.
4. Cumplir especificación ECTC para productos de categoría 4.

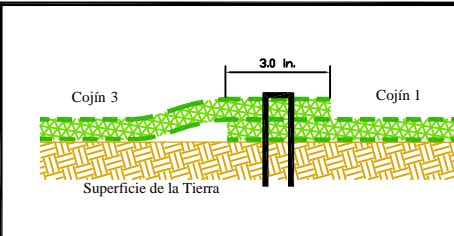

Figura D - Vista del Plano



Figura E - Vista del Plano

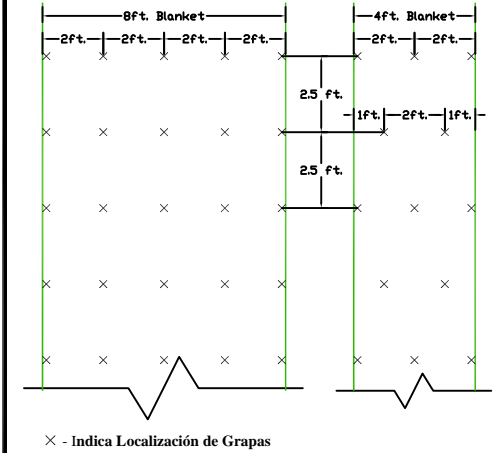

Figura F - Vista de Perfil

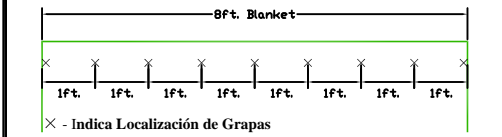

Figura G - Sujeción de Puntos Críticos

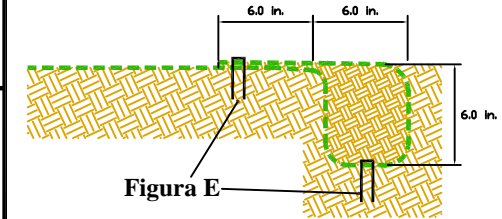
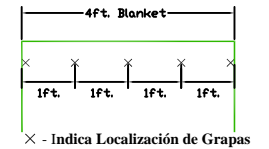

Instalación en Canal

Instrucciones EXCEL SD-3

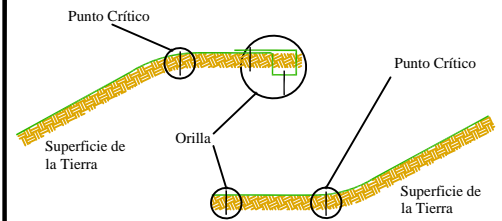
Paso 1 - Preparación del Lugar

Prepare el lugar según el perfil del diseño y de la pendiente. Remueva el escombros, piedras, y terrones, etc. La superficie de la tierra debe estar lisa antes de la instalación para asegurar que el cojín permanezca en contacto con la pendiente.

Paso 2 - Semilla

El sembrado de la semilla en el lugar se debe hacer de acuerdo a los requisitos del diseño o a los requisitos locales y estatales, según sea necesario.

Paso 3 - Selección de Grapas

Lo mínimo que se debe usar son grapas de calibre 11, de 6 in. de largo y 1 in. de corona para sujetar el cojín a la superficie de la tierra. La instalación en tierra rocosa, arenosa o suelta puede requerir grapas más largas.

Paso 4 - Excave Zanja para Anclaje y Sujete el Cojín

Excave una zanja a lo largo de la parte superior de las pendientes de los lados del canal y la orilla de arriba del canal para sujetar las orillas del cojín. La zanja debe correr a lo largo y ancho de la instalación, tener 6 in. de ancho y 6 in. de profundidad. Engrape el cojín a lo largo del fondo de la zanja; llénela con tierra compactada, empalme el cojín hacia la parte inferior de la pendiente y sujételo con una hilera de grapas (Vea las Figuras A, E y F).

Paso 5 - Sujete el Cuerpo del Cojín

Desenrolle el cojín hacia abajo desde la zanja de anclaje. Engrape el cuerpo del cojín siguiendo el patrón que se muestra en la Figura D. Deje la punta del cojín sin engrapar para que lo pueda empalmar como se muestra en la Figura B. Coloque el cojín que baja por debajo del de arriba para formar un patrón como de tejas. Engrape las uniones como se muestra en la figura E. Sujete el cojín de bajada con el patrón de engrapado que se muestra en la Figura D. El patrón de engrapado de la Figura D refleja el mínimo de grapas que se debe usar. Se pueden requerir más grapas para asegurar que el cojín quede sujetado suficientemente para resistir podadoras y tráfico a pie y para asegurar que el cojín permanezca en contacto con la superficie de la tierra en toda el área. Además, los puntos críticos requieren grapas adicionales. Los puntos críticos están identificados en la Figura G.

Paso 6 - Continúe a lo largo de la Pendiente - Termine la Instalación

Empalme los cojines adyacentes como se muestra en la Figura C y repita el Paso 5. Sujete la parte inferior de la pendiente usando el patrón de grapas que se muestra en la Figura E. Sujete las orillas de la instalación engrapando a intervalos de 1.0' a lo largo de la orilla.

* El Dibujo No Está a Escala Se.



Figura A



Figura B - Vista de Perfil

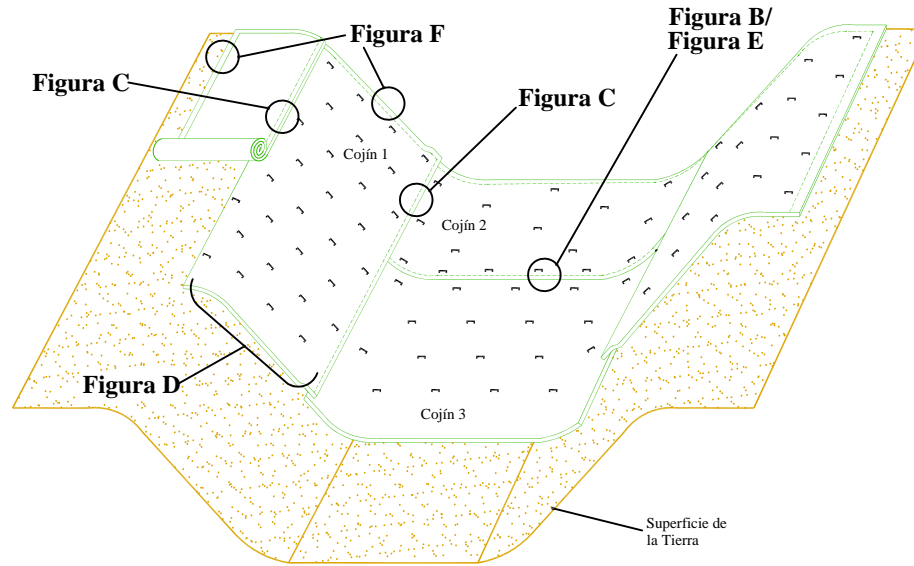

Figura C - Corte de Vista Transversal

Aplicación del Producto/Especificaciones de Equivalencia

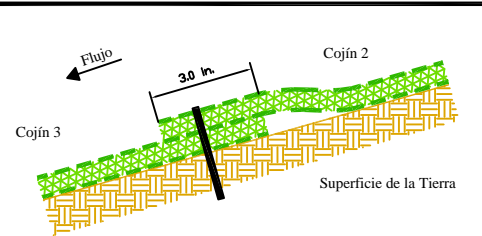
Excel SD-3 es producido por Western Excelsior y consiste de un Producto en Rollo para Control de la Erosión por un término largo (PCER), formado de una matriz de excelsior unida mecánicamente (cosida) entre dos redes sintéticas, de uso rudo, estabilizadas UV (parte superior e inferior). La vida útil del EXCEL SD-3 es aproximadamente 30 meses. (La vida útil real depende del campo y de las condiciones climáticas). El Excel SD-3 se fabrica para incluir propiedades físicas suficientes para proporcionar la vida útil y rendimiento esperado. Las especificaciones del producto se encuentran en el documento WE_EXCEL_SD3_SPEC y la información de rendimiento se puede encontrar en el documento WE_EXCEL_SD3_PERF. Todos los documentos están disponibles en Western Excelsior Technical Support (Soporte Técnico de Western Excelsior) o en www.westernexcelsior.com. Además de lo anterior, los productos equivalentes a Excel SD-3 deben cumplir con los siguientes criterios idénticos a Excel SD-3:

1. Consistente en excelsior producido a máquina, libre de hierbas y basura unido entre dos redes sintéticas de uso rudo, estabilizadas UV (superior e inferior).
2. Suficiente fuerza de tensión, grosor y cobertura para mantener su integridad durante la instalación y asegurar el rendimiento del material.
3. Incluido en la base de datos AASHTO NTPEP.
4. Cumplir especificación ECTC para productos de categoría 4.

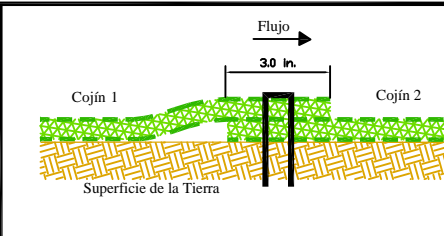

Figura D - Vista del Plano



Figura E - Vista del Plano

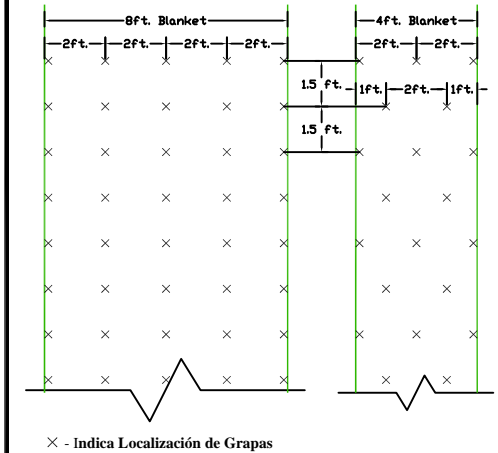

Figura F - Vista de Perfil

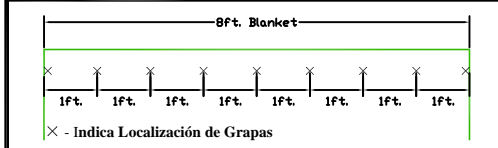
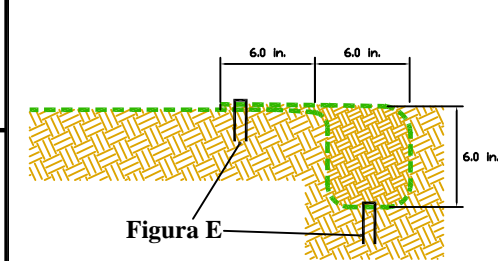
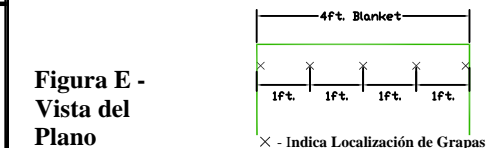
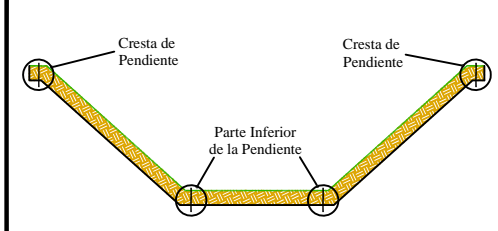

Figura G - Sujeción de Puntos Críticos